

Name: **Factory Setup** Date: \_\_\_\_\_

Race Track: \_\_\_\_\_

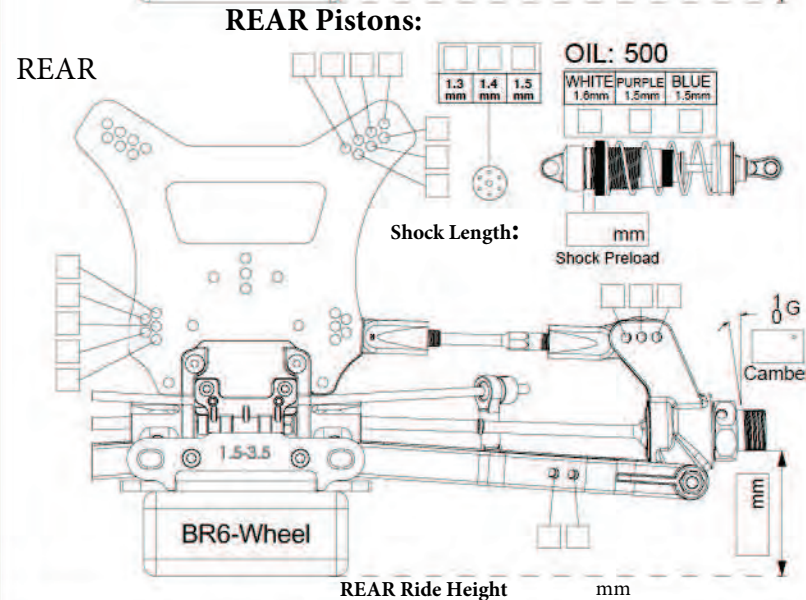
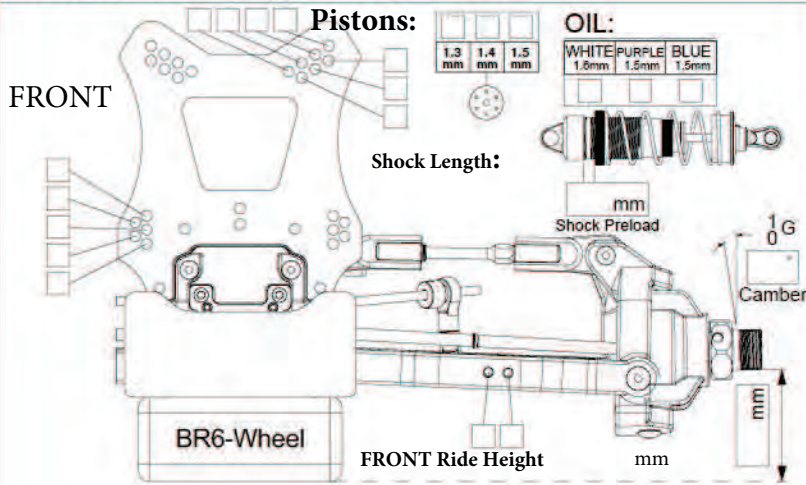

TRACK NOTES:

FRONT SPRINGS

REAR SPRINGS



set the table angle

Insert	-1	-0.75	-0.5	-0.25	0	0.25	0.5	0.75	1
Angle	0	0.25	0.5	0.75	1	1.25	1.5	1.75	2

NOTES:



NOTES:



set the table angle

Insert	-1	-0.75	-0.5	-0.25	0	0.25	0.5	0.75	1
Angle	1.5	1.75	2	2.25	2.5	2.75	3	3.25	3.5

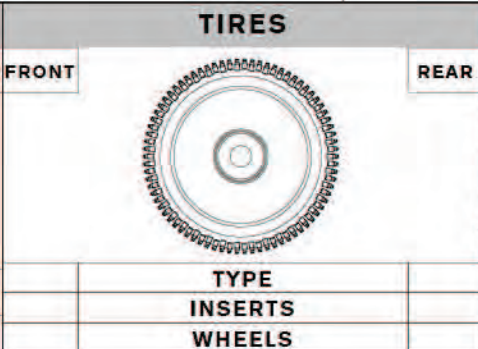
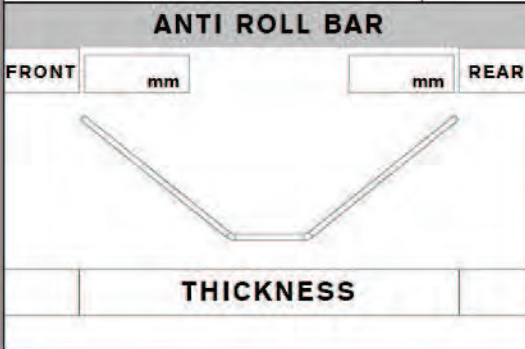
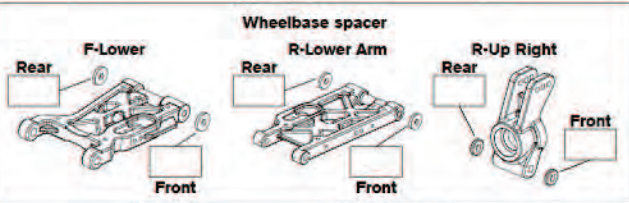
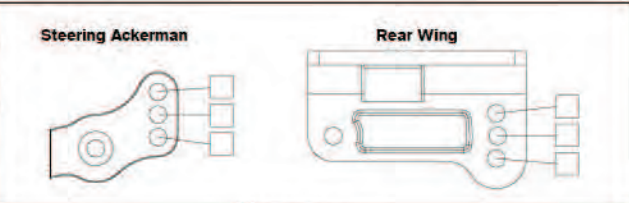
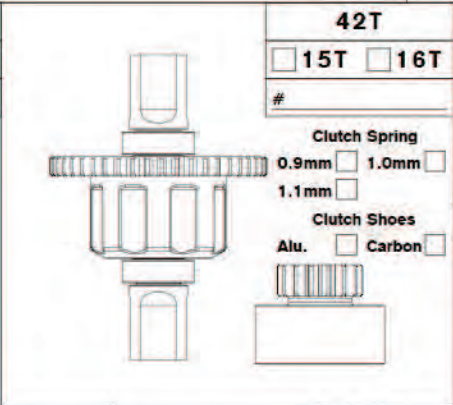
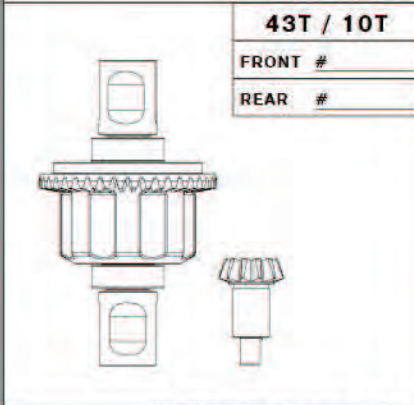

**ENGINE**

TYPE	_____
MANIFOLD	_____
MUFFLER	_____
PLUG	_____
FUEL	_____
<b>BODY</b>	
TYPE	_____